

PACIFIC

TRU**ST**EAM

OPERATING INSTRUCTION

Model number: SC8130S /SC8136S /SC8130W /SC8136W



SC8230S /SC8236S /SC8230W/SC8236W
SC8830S /SC8836S /SC8830W/SC8836W



Serial Number: _____

Read all instructions before operating the range hood.

IMPORTANT SAFETY NOTICE

READ AND SAVE THESE INSTRUCTIONS

WARNING

TO REDUCE THE RISK OF FIRE OR ELECTRIC SHOCK, DO NOT USE THIS FAN WITH ANY SOLID-STATE CONTROL DEVICE.

WARNING

TO REDUCE THE RISK OF FIRE ELECTRIC SHOCK, OR INJURY TO PERSONS, OBSERVE THE FOLLOWING:

- a) Use this unit only in the manner intended by the manufacturer, if you have questions, contact the manufacturer.
- b) Before servicing or cleaning unit, switch power off at service panel and lock the service disconnecting means to prevent power from being switched on accidentally. When the service disconnecting means cannot be locked, securely fasten a prominent warning device, such as a tag, to the service panel.

CAUTION

For General ventilating Use Only. Do Not Use To Exhaust Hazardous Or Explosive Materials And Vapors.

WARNING -

TO REDUCE THE RISK OF A RANGE TOP GREASE FIRE:

- a) Never leave surface units unattended at high settings. Boilovers cause smoking and greasy spillovers that may ignite. Heat oils slowly on low or medium settings.
- b) Always turn hood ON when cooking at high heat or when flaming food. (i.e. Cherries Jubilee, Peppercom Beef Flambe').
- c) Clean ventilating fans frequently. Grease should not be allowed to accumulate on fan or filter.
- d) Use proper pan size. Always use cookware appropriate for the size of the surface element.
- e) Keep fan, filters and grease laden surfaces clean.
- f) Use high setting on hood only when necessary.
- g) Don't leave hood unattended when cooking.
- h) Always use cookware and utensils appropriate for the type of and amount of food being prepared.

WARNING -

TO REDUCE THE RISK OF INJURY TO PERSONS IN THE EVENT OF A RANGE TOP FIRE, OBSERVE THE FOLLOWING:

- a) SMOTHER FLAMES with a close-fitting lid, cookie sheet, or metal tray, then turn off the burner. BE CAREFUL TO PREVENT BURNS. If the flames do not go out immediately, EVACUATE AND CALL THE FIRE DEPARTMENT.
- b) NEVER PICK UP A FLAMING PAN – You may be burned.
- c) DO NOT USE WATER, including wet dishcloths or towels – a violent steam explosion will result.
- d) Use an extinguisher ONLY if:
 - 1) You know you have a Class ABC extinguisher, and you already know how to operate it.
 - 2) The fire is small and contained in the area where it started.
 - 3) The fire department is being called.
 - 4) You can fight the fire with your back to an exit

WARNING -

TO REDUCE THE RISK OF FIRE, ELECTRIC SHOCK OR INJURY TO PERSONS, OBSERVE THE FOLLOWING:

IMPORTANT SAFETY NOTICE

- a) Installation work and electrical wiring must be done by qualified person(s) in accordance with all applicable codes and standards, including fire-rated construction.
- b) Sufficient air is needed for power combustion and exhausting of gases through the flue (chimney) of fuel burning equipment to prevent back-drafting. Follow the heating equipment manufacturer's guideline and safety standards such as those published by the National Fire Protection Association (NFPA) and the American Society for Heating, Refrigeration and Air Conditioning Engineers (ASHRAE) and the local code authorities.
- c) When cutting or drilling into wall or ceiling, do not damage electrical wiring and other hidden utilities.
- d) Ducted fans must always vent to the outdoors.
- e) NEVER place a switch where it can be reached from a tub or shower.
- f) Make sure the power is off before installing, wiring or maintenancing.

WARNING

TO REDUCE THE RISK OF FIRE, USE ONLY METAL DUCTWORK.

CAUTION

To reduce risk of fire and to properly exhaust air outside - Do not vent exhaust air into spaces within walls, ceilings, attics, crawl spaces or garages.

OPERATION

Always leave safety grilles and filters in place. Without these components, operating blowers could catch onto hair, fingers and loose clothing.

The manufacturer declines all responsibility in the event of failure to observe the instructions given here for installation, maintenance and suitable use of the product. The manufacturer further declines all responsibility for injury due to negligence and the warranty of the unit automatically expires due to improper maintenance.

ELECTRICAL REQUIREMENTS

Important: Observe all governing codes and ordinances.

It is the customer's responsibility:

- To contact a qualified electrical installer.
- To assure that the electrical installation is adequate and in conformance with National Electrical Code, ANSI/NFPA 70 latest edition* or CSA standards C22.1-94, Canadian Electrical Code, Part 1 and C22.2 No.0-M91 - latest edition** and all local codes and ordinances.

If codes permit and a separate ground wire is used, it is recommended that a qualified electrician determine that the ground path is adequate.

Do not ground to a gas pipe.

Check with a qualified electrician if you are not sure the range hood is properly grounded.

Do not have a fuse in the neutral or ground circuit.

*National Fire Protection Association Batterymarch Park, Quincy, Massachusetts 02269

** CSA International 8501 East Pleasant Valley Road, Cleveland, Ohio 44131-5575

This appliance requires a 120V 60Hz electrical supply and connected to an individual properly grounded branch circuit protected by a 15 or 20 ampere circuit breaker or time delay fuse. Wiring must be 2 wire with ground. Please also refer to Electrical Diagram on product.

A cable locking connector (not supplied) might also be required by local codes.

Check with local requirements, purchase and install appropriate connector if necessary.

Table of Content

I. Product Functions/Performance Specification Chart	1
II. Parts Instructions - SC8130S/W,SC8136S/W	2
Parts Instructions - SC82xxS/W & SC88xxS/W	3
III. Installation Guidelines	4
IV. Installation Procedures - SC8130S/W,SC8136S/W	5
Installation Procedures - SC82xxS/W & SC88xxS/W	6
V. Venting Instruction	7
VI. Operating Instructions - SC8130S/W,SC8136S/W	8
Operating Instructions - SC8230S/W,SC8236S/W	9
Operating Instructions - SC8830S/W,SC8836S/W	10
VII. Replacing Light Bulb	11
VIII. Surface Maintenance	12
IX. Remarks	13
X . Troubleshooting	14

I. Product Functions/Performance Specification Chart

A. Product Functions

1. The hood has built-in memory function,It will remember the last speed and light level it was last turned off at .
2. Fan speed adjustment.
3. 2 levels brightness adjustment
4. Delay off function.
5. Steam clean function.
6. LCD panel indicates (SC88/SC82)/LED blue-ray indicates: fan speed, steam clean, delay off ; button function: power, speed, light delay off, steam clean.

B. Specification Chart



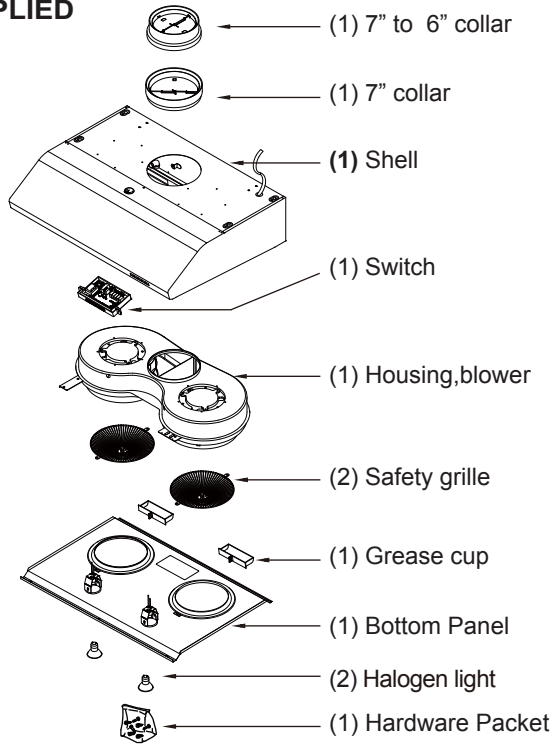

Models	SC8130S(W)	SC8136S(W)
Weight(Pound)	33.66 lbs	36.86 lbs
Measurement(inches)	30"X22-1/16"X7-1/16"	36"X22-1/16"X7-1/16"
Maximum Voltage	120V – 60Hz	120V – 60Hz
Exhaust Pipe Diameter	7 inches	7 inches
Light	Halogen light 35Wx2	Halogen light 35Wx2
Maximum consumption power	10A/1200W	10A/1200W
Models	SC8230S(W) / SC8830S(W)	SC8236S(W) / SC8836S(W)
Weight(Pound)	38.14 lbs	42.11 lbs
Measurement(inches)	30"X23"X8"	36"X23"X8"
Maximum Voltage	120V – 60Hz	120V – 60Hz
Exhaust Pipe Diameter	7 inches	7 inches
Light	LED light 3Wx2 / Halogen light 50Wx2	LED light 3Wx2 / Halogen light 50Wx2
Maximum consumption power	10A/1200W	10A/1200W

II. Parts Instructions - SC8130S/W & SC8136S/W









PARTS SUPPLIED



HARDWARE PACKAGE CONTENTS (For Canada)

TYPE		DESCRIPTION	N°	TYPE		DESCRIPTION	N°
A		Wire Nuts	3	C		M6 x 1-1/2" wood screws	4
B		5 x 24m/m Washers	4	D		Halogen light Suction Cup	1

HARDWARE PACKAGE CONTENTS (For USA)

TYPE		DESCRIPTION	N°	TYPE		DESCRIPTION	N°
A		Wire Nuts	3	E		Halogen light Suction Cup	1
B		5 x 24m/m Washers	4	F		M6 x 2" wood screws	4
C		3/16 x 1/2 screws	4	G		M6 x 1" wood screws	2
D		M6 x 1-1/2" wood screws	4	H		Wall bracket	2

II. Parts Instructions-SC8230S/W, SC8236S/W,SC8830S/W, SC8836S/W

PARTS SUPPLIED:

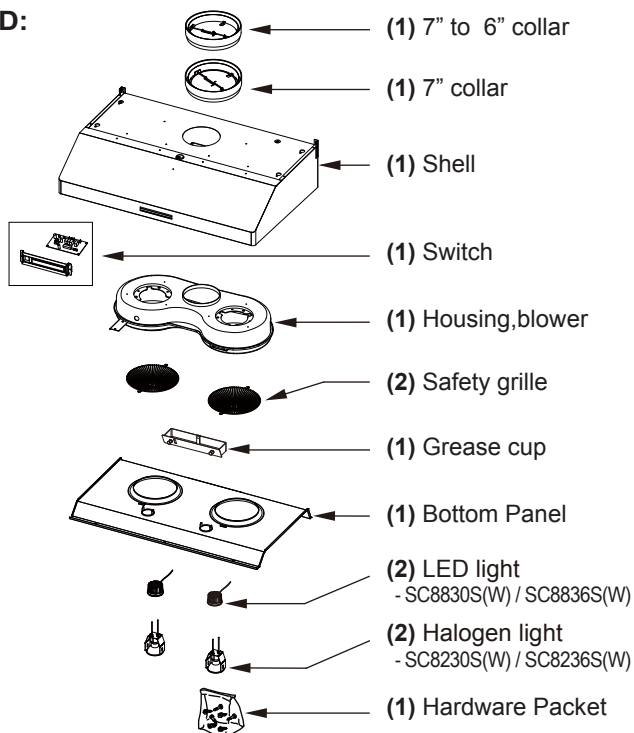

HARDWARE PACKAGE CONTENTS (For Canada)

TYPE		DESCRIPTION	N°	TYPE		DESCRIPTION	N°
A		Wire Nuts	3	C		M6 x 1-1/2" wood screws	4
B		5 x 24m/m Washers	4	D		Halogen light Suction Cup SC8230S(W) / SC8236S(W)	1
E		M4*8 screws	4				

HARDWARE PACKAGE CONTENTS (For USA)

TYPE		DESCRIPTION	N°	TYPE		DESCRIPTION	N°
A		Wire Nuts	3	E		Halogen light Suction Cup SC8230S(W) / SC8236S(W)	1
B		5 x 24m/m Washers	4	F		M6 x 2" wood screws	4
C		3/16 x 1/2 screws	4	G		M6 x 1" wood screws	2
D		M6 x 1-1/2" wood screws	4	H		Wall bracket	2

III. Installation Guidelines

1. Surrounding Environment (Pic.1)

Check the surrounding of range hood. If there are too many windows or a doors nearby, it is advisable to close the windows and doors before turning on the range hood to prevent the external convection and affecting the ventilation.

The smoke has to rise up to 10inches from the stove/grate to be within the range of venting efficiency.

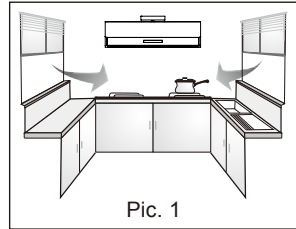

Too many windows, too much convection

2. Installation Heights (Pic.2)

The ideal installation height is a distance of 24 to 30inches from the bottom of the range hood to the surface of the stove top.

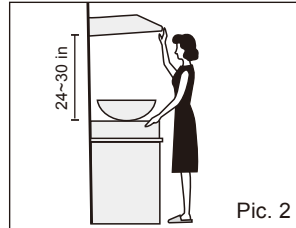

3. Hood installed in parallel and horizontal level (Pic.3)

The front, back, right and left of hood must be in parallel and horizontal level, to avoid the oil in the oil tub from spilling over. To ensure that the hood is leveled when installing, it can be measured by the hook mark for the left and right side; and the screws fixed securely onto the wall to ensure the front and back of the hood are parallel.

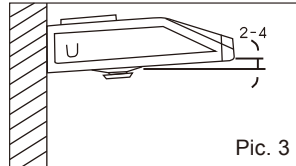

4. Exhaust duct

In order to increase the venting efficiency of hood, recommend to use the 7 inch duct to maintain best air flow efficiency; the length of duct must to be minimized.

5. Socket arrangement

Please do not plug the range hood to the socket with the other high electricity consumption appliances.



※ Before installing the hood, please apply fast drying glue to the collar and securely attach it to the top of the range hood's vent lid. Install the range hood and attach pipe to the plastic collar and seal with aluminum tape and prevent steam and smoke leakage.

IV. Installation Procedures-SC8130S/W & SC8136S/W

Hood is designed for installation under a kitchen cabinet.

See Fig.1 for details.

1. Prepare duct location on hood .
2. Measure and cut out duct and electrical openings in cabinet or wall to match up with the hood. Make sure duct opening is large enough to apply aluminum duct tape.
3. Reinforce cabinet bottom with wood strips if additional strengthening is required or if cabinets are framed.
4. Remove bottom panel from hood using a Philips screwdriver to remove each of the screws. Also remove lighting harness by pressing in on the clip to release the lights from the internal wiring.
5. Use 4 wooden screws to secure the hood to the bottom of the cabinet.
6. Lift hood onto screws located on cabinet bottom and lock into place. Make sure all(4) key-holes cover the screws. Tighten each screw to secure hood to cabinet.
7. Install electrical.
8. Install ductwork and seal with aluminum duct tape.
9. Power up hood and check for leaks around duct tape and test all functions.
10. Reinstall bottom panel and reconnect lighting harness.
11. Slide oil cups into their openings on the bottom of the hood. Install protection grilles over each blower opening and secure with the pre-installed screw.

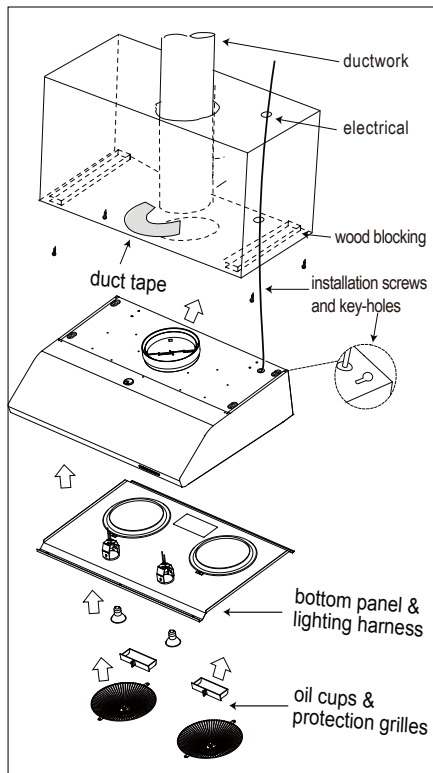

Fig 1

IV. Installation Procedures-SC8230S/W, SC8236S/W,SC8830S/W, SC8836S/W

**Hood is designed for installation under a kitchen cabinet.
See Fig.1 for details.**

1. Prepare duct location on hood .
2. Measure and cut out duct and electrical openings in cabinet or wall to match up with the hood. Make sure duct opening is large enough to apply aluminum duct tape.
3. Reinforce cabinet bottom with wood strips if additional strengthening is required or if cabinets are framed.
4. Remove bottom panel from hood using a Philips screwdriver to remove each of the screws. Also remove lighting harness by pressing in on the clip to release the lights from the internal wiring.
5. Use 4 wooden screws to secure the hood to the bottom of the cabinet.
6. Lift hood onto screws located on cabinet bottom and lock into place. Make sure all (4) key-holes cover the screws. Tighten each screw to secure hood to cabinet.
7. Install electrical.
8. Install ductwork and seal with aluminum duct tape.
9. Power up hood and check for leaks around duct tape and test all functions.
10. Reinstall bottom panel and reconnect lighting harness.
11. Slide oil cups into their openings on the bottom of the hood. Install protection grilles over each blower opening and secure with the pre-installed screw.

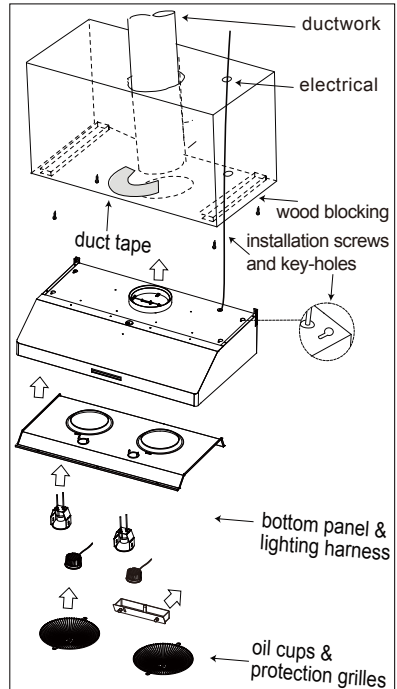

Fig 1

V. Venting Instruction

WARNING FIRE HAZARD

NEVER exhaust air or terminate duct work into spaces between walls, crawl spaces, ceiling, attics or garages. All exhaust must be ducted to the outside. Use metal ductwork only.





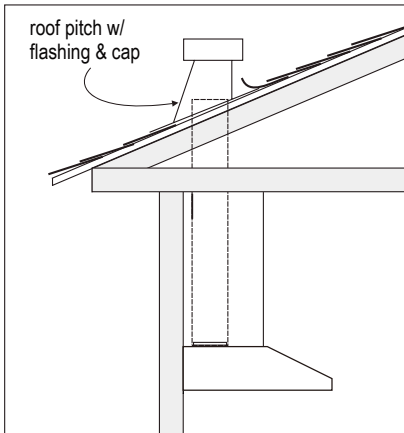
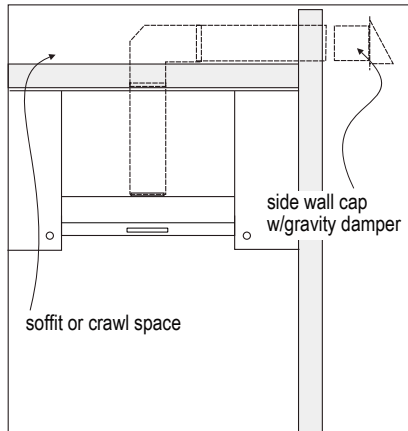
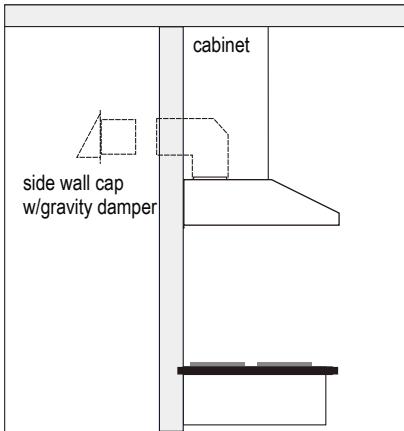











Fasten all connections with sheet metal screws and tape all joints with certified Silver Tape or Duct Tape.

Ducting Options



VI. Operating Instructions-SC8130S/W & SC8136S/W



1.  On/Off & Delay Off:
 - (1)  On/Off
 - Press to turn on the fans and press again to turn off the fans.
 - From fans are off, press to turn on the range hood at the last speed and light level it was turned off at.
 - (2)  Delay-off
 - With the fans on or off press and hold this button for 3 seconds to start the delay off. The fans will change to speed 1 and this button will blink on and off indicating delay off function has started. The fans and light will automatically turn off after 5 minutes.
 - The fans speed is adjustable during delay off.
 - Clean function is not available during delay off.
 - When activating the fans or steam clean, the  will lights on.
 - Delay-Off speed indicator Speed 1 : only  blinks. Speed 2 : only  blinks. Speed 3 : both  and  blink.
2.  Light Switch:
 - (1) Lights are two levels, press once is light, press again is dim, press again is turn off.
3.  Speed Up:
 - (1) Press this button to decrease fan speed, fan speed will change from 1 → 2 → 3 → 3 (Highest speed).
 - (2) From fans are off, press to turn on the range hood at the last speed and light level it was turned off at.
4.  Speed Down:
 - (1) Press this button to increase the fan speed, fan speed will change from 3 → 2 → 1 → 1 (Lowest speed).
 - (2) From fans are off, press to turn on the range hood at the last speed and light level it was turned off at.
 - Speed indicator: Speed 1 : only  lights on. Speed 2 : only  lights on. Speed 3 : both  and  light on.
5.  Steam Clean:
 - (1) Press this button to decrease fan speed, fan speed will change from 1 → 2 → 3 → 3 (High speed).
 - (2) Press this button can turn on the fans at the last memorized fan speed.
 - When low water level, the  will blink.

VI. Operating Instructions-SC8230S/W & SC8236S/W



1. on/off:

(1) Press to turn on the fans and press again to turn off the fans.

2. Light switch:

(1) LCD indicate $L \overset{\text{H}}{\circ}$ when start lamp function

(2) From off, press one time for bright light (the "H" on the LCD screen will blink). Press again for dim light (the "L" on the LCD screen will blink). Press again to power lights off.

(3) The button is not controlled by on / off and delay off.









3. Delay off / Fan Speed

(1) Press for 2 seconds to start delay off and fan runs at the lowest speed automatically. The range hood will turn off after 5 minutes. The  on the LCD screen will but light is not impacted.

(2) Under this mode, speed can be adjusted. Steam clean is not available.

(3) Under this mode, press the button 2 seconds to stop delay off function; press on/off to turn off fans.

(4) Fan speed can be changed by pressing this button.

The LCD will indicate fan speed:    (Low) /    (mid) /    (High) °

(5) When fans are off, press this button and fans will start at last speed and light when it was last turned off at.

4. Steam clean

(1) Press to start steam cleaning process, when the range hood is cleaning, The  on the LCD screen will blink during steam cleaning process.





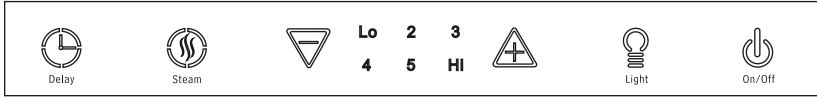

(2) During the steam cleaning process, the fan speed button is not be available.

(3) When water level is low, the  on the LCD screen will blink.

(4) Steam function will auto-locking when the function is unusual, the  on the LCD screen will blink.

VI. Operating Instructions-SC8830S/W & SC8836S/W



-  On/off:
 - (1) Press to turn on the fans and press again to turn off the fans.
-  Light switch:
 - (1) From off, press one time for bright light. Press again for dim light. Press again to turn lights off.
 - (2) The button is not controlled by on / off and delay off.
-  Speed up
 - (1) This button will increase the speed with each press.
 - (2) Press the speed up or speed down button when the fans are off to turn on the range hood at the last speed and light level it was last turned off at
-  Speed down
 - (1) This button will decrease speed with each press.
 - (2) Press the speed up or speed down button when the fans are off to turn on the range hood at the last speed and light level it was last turned off at.
-  Steam clean
 - (1) Press to start steam cleaning process, the indication light is illuminate when the range hood is cleaning.
 - (2) When steam cleaning process is operating, speed up and down buttons are not available.
 - (3) When water level is low, the steam clean button will blink to warn until water is added.
 - (4) Steam clean function will auto-locking when the function is unusual, all indication lights will blink.
-  Delay Off
 - (1) Press one time to start the delay off function, range hood is adjusted to the lowest speed automatically, it will turn off after 5 minutes. But light is not impacted.
 - (2) Under this mode, speed can be adjusted. Steam clean function is not available.
 - (3) Under this mode, press the button again will stop the delay off function. Light will not be impacted. Press on/off button to turn off the fans.

VII. Replacing Light Bulb

Attention:

When the range hood is activated or has been running for a long time, be careful when handling the light bulb as it may be too hot to handle.

Please double check to make sure the power supply to the range hood is shut off and the light bulb is cool before removing it.

Remove the panel and detach the electrical wire connected to the light bulb.

LED light:

Each light bulb has two screws that secure it (see picture below).

After removing the screws, the light bulb will come off.

Please contact dealer to purchase new light bulbs.

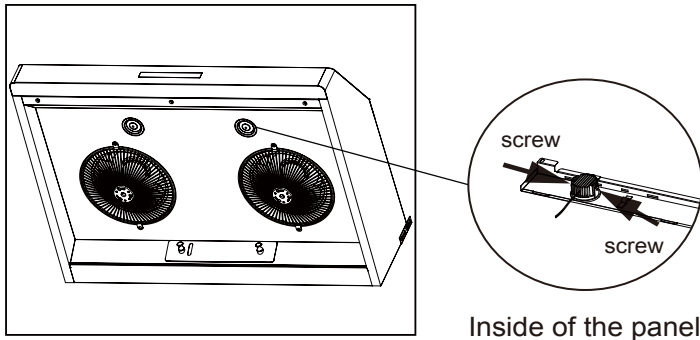

Halogen light:

When the range hood is activated or has been running for a long time, be careful when handling the light bulb as it may be too hot to handle.

Please double check to make sure the power supply to the range hood is shut off and the light bulb is cool before removing it.

Remove the Halogen bulb by turning it counter-clockwise to remove.

The black rubber suction tool in the hardware package is for removing the halogen light bulb.

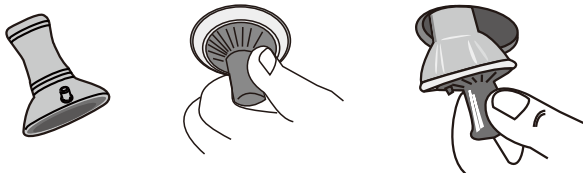

VIII. Surface Maintenance

A. Surface Maintenance

1. Please clean the range hood surface regularly with warm soapy water and wipe with a cotton cloth to prevent grease from accumulating.
2. Please do not use harsh cleansers or coarse material to clean the surface because that will damage the surface.
3. A non-invasive stainless steel polish is recommended to polish the surface after cleaning.
4. Please use soft cloth for polishing because it will make your range hood surface shinier.
5. Please do not use cleaning solutions that have bleach as an ingredient.

B. Surface Cleaning and Maintenance

1. Always disconnect from power supply before cleaning.
2. Clean both exterior and interior of the hood for long lasting. Do not use abrasive cleanser.
3. Fan's protection grille can be detached for cleaning by removing the screws with a screwdriver. It must be reinstalled before using the range hood again.
4. Oil dish on the grille can also be detached for cleaning by turning the dish counter-clockwise.
5. The oil cup in the centre of the hood for holding grease can be detached and cleaned regularly.
6. Make a habit of turning on the range hood first before turning on the stove to avoid high temperature in the kitchen.

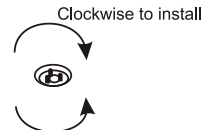
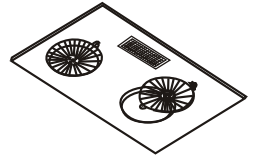

counterclockwise to detach

IX. Remarks

A. Functions:

1. The range hood shall be cleaned by using distilled water or decalcified water only. The cleaning process works on the centrifuga force and cleaning power generated by revolving the motors at high speed, It will keep the inside of the blower housing clean and prolong the lifespan of the range hood.
2. steam clean function will auto-locking when the function is unusual, Please must contact supplier to check and repair.

B. Operating Instructions:

1. To pour distilled water or decalcified water into provided jar.
2. Pour distilled water or decalcified water from the jar into the hidden water storage unit of the range hood through the water inlet as shown in the picture. First time use the hood, please pour the volume of two storage units.
3. Press the steam clean button to start the motors and the distilled water or decalcified water will be discharged automatically and cleans the inside of the range hood.
4. The oil retainer shall be taken out to remove the dirty oil once the dirty oil and residue reaches the window of oil retainer to prevent spillage.

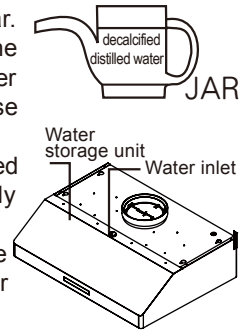

C. Precautions:

1. The oil retainer shall be taken out to remove the dirty oil once the dirty oil reaches the window of oil retainer to prevent spillage.
2. Use the provided jar to pour distilled water or decalcified water.
3. Consumers are advised to clean the range hood twice a week. It may be cleaned less frequently according to individual needs.
4. When filling the range hood with the distilled water or decalcified water, use only the provided jar. Use the provided jar with the range hood and take precautions not to overfill the cleaner storage unit.
5. Check and empty the oil retainer after the cleaning process to prevent oil spillage. Do not allow dirty oil and residue to exceed the height of window.
6. Do not put any other substances into the water storage unit as this will cause blockage of its steam nozzle.
7. Suggest to take out the oil retainer to remove the dirty oil after every steam clean.

X. Troubleshooting

Problem	Possible Cause	Solution
Motor stops running	1. No power (burned wire or fuse)	1. Replace the PC board
	2. Motor temperature regulator is off and can't be recovered	2. Replace motor
	3. Motor copper wire is burned	3. Replace motor
	4. Capacitor defected	4. Replace capacitor
	5. No power (burned wire) or burned fuse	5. Check power meter (replace power cord)
Motor speed slows down automatically	1. Distorted capacitor or low power	1. Replace capacitor
	2. Motor defected	2. Replace motor
Inverted fan blades	1. Short circuit on the motor	1. Replace motor
	2. Air comes out of the air outlet instead of sucks up	2. Air outlet or exhaust pipe is blocked and needs cleaning
Motor doesn't regulate speed	1. Capacitor defected	1. Replace capacitor
	2. Electrical wiring is off	2. Fix the electrical wires
Motor runs on and off	1. Motor stops running when it reaches unusual high temperature, and starts again when it cools down to normal cooking temperature This is cause by temperature running too high during cooking.	1. Recommend changing your cooking routine slightly
	2. Motor temperature regulator comes on and off	2. Replace motor 3. Change the motor electrical wiring and de-activate the temperature regulator.
Delay-Off function fails	1. Main control PC board failed	1. Replace main control PC board
	2. PC board switch failed	2. Replace PC board switch
Power leakage	1. Water got in the motor	2. Replace motor
Two sections of the LED light not working	1. Short circuit on LED light control power cord	1. Replace LED light control power cord
	2. Short circuit on the light power cord in the main control PC board	2. Replace main control PC board
	3. LED light failed	3. Replace LED light
Two sections of the Halogen light not working	1. Short circuit on Halogen light control power cord	1. Replace Halogen light control power cord
	2. Short circuit on the light power cord in the main control PC board	2. Replace main control PC board
	3. Halogen light failed	3. Replace Halogen light
Display unit failed	1. Main control PC board failed	1. Replace main control PC board
	2. PC board switch failed	2. Replace PC board switch
Steam clean failed	1. Check water level	1. Refer to IX. Remarks for instruction
	2. PC board failed	2. Replace PC board
	3. Nozzle is clogged	3. Check nozzle
	4. Water pump failed	4. Change water pump
	5. Steam function is locked. Indication light of user interface blink to notice	5. Press steam key 5 sec. to reset then re-try steam function. if it is still unusual situation, please contact supplier immediately.

十. 排除故障

異常狀況	原因	處理方式
馬達不轉	1. 無電源輸入(電源線燒毀)或保險絲燒毀	1. 更換PC板
	2. 馬達溫控跳脫無法回復	2. 更換馬達
	3. 馬達銅線燒毀	2. 更換馬達
	4. 電容器燒毀	4. 更換電容器
	5. 無電源輸入(電源線燒毀)或保險絲燒毀	5. 三用電表測(更換電源線)
馬達轉速變慢	1. 電容器變形或電量不足	1. 更換電容器
	2. 馬達燒毀	2. 更換馬達
風葉有反轉現象	1. 馬達銅線短路	1. 更換馬達
	2. 出風口逆風現象(倒灌風)	2. 出風口或排風管阻塞清理
馬達無分段速度	1. 電容器燒毀	1. 更換電容器
	2. 線路脫落	2. 重整電線
馬達時轉時不轉	1. 溫控在感應到異常高溫時，馬達會停止轉動，當溫度降到一般煮食時，會恢復正常運作	1. 建議煮食方法稍改： 若煮食時長時間用大火，建議改用中小火或暫停煮食
	2. 馬達溫控跳脫會時有時無	2. 更換馬達 3. 更改馬達結線，不使用溫控
Delay Off延遲失效	1. 主控PC板失效	1. 更換主控PC板
	2. 開關PC板失效	2. 更換開關PC板
漏電	1. 馬達入水造成	1. 更換馬達
LED燈兩段失效	1. LED燈控制線斷路	1. 更換LED燈控制線
	2. 主控PC 板燈線斷路	2. 更換主控PC板
	3. LED燈故障	3. 更換LED燈
鹵素燈兩段失效	1. 鹵素燈控制線斷路	1. 更換鹵素燈控制線
	2. 主控PC 板燈線斷路	2. 更換主控PC板
	3. 鹵素燈故障	3. 更換鹵素燈
顯示器失效	1. 主控PC板失效	1. 更換主控PC板
	2. 開關PC板失效	2. 更換開關PC板
蒸氣清洗失效	1. 檢查面板是否有警示缺水狀況	1. 依說明書九. 注意事項指示添加去鈣產品或蒸餾水
	2. 開關PC板失效	2. 檢查PC板或更換PC板
	3. 噴水孔堵塞	3. 檢查噴水孔
	4. 噴水馬達失效	4. 更換噴水馬達
	5. 檢查面板是否有指示燈閃爍，警示該鎖定功能已啟動	5. 按住STEAM鍵5秒後重置設定，請再試一次蒸氣清洗功能。如仍有異常，請連絡經銷商進行維修。

九. 注意事項

一. 功能說明

1. 本機利用蒸餾水注入機器內水箱備用，以馬達高速運轉時之離心力及衝擊力，達到清洗內部的功能，可永保抽油煙機內部清潔延長抽油煙機使用壽命。
2. 蒸氣清洗功能有安全自動鎖定設計，如有異常狀況即鎖定清洗功能。如被鎖定及其他異常狀況，請立即連絡經銷商，務必請專業維修人員協助詳細檢測及維修。

二. 操作說明

1. 使用專用水壺，加入蒸餾水或去鈣離子水之指定分量。
2. 將水壺從機器之注入口倒入蒸餾水或去鈣離子水，抽油煙機內有隱藏式水箱，第一次使用此油機，請加入兩壺的水量。
3. 按蒸氣清洗鍵即啟動馬達，機器自動噴出蒸氣，清洗機器內部。
4. 油杯外觀有透視窗，水位已達透視窗可見位置時，即應取下倒去油污以防外溢。

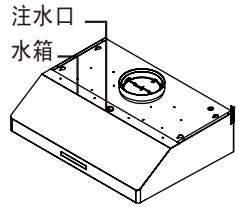

三. 注意事項及警告標示

1. 清潔時請使用蒸餾水或去鈣離子水。
2. 請按照隨機附有的水壺指示添加蒸餾水或去鈣離子水。
3. 建議消費者一星期清洗2次即可，亦可按需要減少清洗次數。
4. 注入蒸餾水時，請用隨機附上的水壺小心倒進水箱，勿使蒸餾水溢出機外。
5. 清洗時注意，勿使油污超過透視窗高度，以防油污溢出。
6. 請謹防異物流入水箱中，以防噴水孔堵住。
7. 建議每次清洗後，請取下油杯倒去油污，以防外溢。

八. 機身表面保養和清潔

一. 機身表面保養

1. 請定期以熱肥皂水和棉布擦拭機身以防油垢堆積。
2. 請勿使用腐蝕性洗碗精和材質過粗的布料擦拭，以免傷害到機身表面。
3. 擦拭完成後建議使用無刺激性的不鏽鋼拋光劑來進行第二次擦拭。
4. 請使用軟布輕擦，您的油煙機表面將會更加光亮。
5. 請勿使用含有漂白成分的清潔液。

二. 保養和清潔

1. 清潔前，務必要切斷電源。
2. 定期清潔抽油煙機的內外側，可以保持抽油煙機壽命，切勿使用研磨性清潔劑。
3. 用螺絲刀拆卸螺絲，可拆卸風扇保護清潔完成後，必須重新裝回原位。
4. 按逆時針方向旋轉，可拆卸附在保護網的馬達盛油器清潔。完成後即可重新裝回原位。
5. 抽油煙機中央的盛油杯可拆卸做定期清潔。
6. 在開啟煮食爐前，請先開啟抽油煙機以免廚房溫度太高。

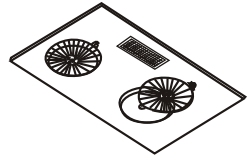

七. 移除燈炮

LED燈移除注意：

當油煙機在運轉或經過長期運轉後請小心燈泡高溫。請務必關閉電源並等待燈泡冷卻後再移除燈泡。

移除煙罩板，拔除內部燈泡連結電線。每個燈泡皆有兩個螺絲（位置如下圖），卸下螺絲後燈泡將自行摘落。請洽經銷商購買新燈泡。

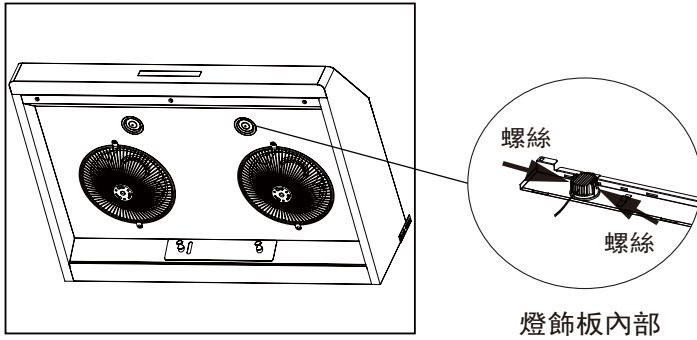

鹵素燈移除注意：





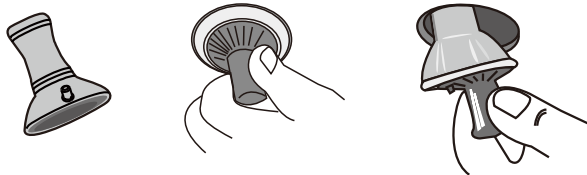

當油煙機在運轉或經過長期運轉後請小心燈泡高溫。請務必關閉電源並等待燈泡冷卻後再移除燈泡。

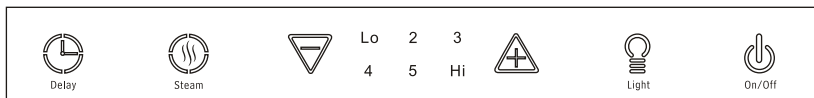
請用黑色吸盤（隨機附上），以順時針旋轉拆除，並參考以下圖示移除燈泡。請洽經銷商購買新燈泡。













六. 按鍵說明-SC8830S/W & SC8836S/W



-  電源/開關按鍵：
 - 按壓一次開啟風扇；再按壓一次關閉風扇。
-  電燈按鍵：
 - 按第一次全亮；按第二次微亮；再按一次關閉電燈。
 - 此按鍵獨立控制不受電源/開關按鍵和延遲開關按鍵影響。
-  風速加速按鍵：
 - 風速上調至高速為止，每按一次則速度遞增。
 - 在風扇停止運轉時，按風速減速按鍵或風速加速按鍵即以上次關機之速度啟動。
-  風速減速按鍵：
 - 風速下調至低速為止，每按一次則速度遞減。
 - 在風扇停止運轉時，按風速減速按鍵或風速加速按鍵即以上次關機之速度啟動。
-  蒸氣清洗按鍵：
 - 按下開始蒸氣清洗流程，清洗動作時燈恆亮，其餘時熄滅狀態。
 - 啟動蒸氣清洗時，按風速上、下鍵皆無效。
 - 缺水時，按此鍵無效並且會持續閃爍警示，直到加水為止。
 - 清洗功能異常時，會啟動自動鎖定功能，所有指示燈會閃爍警示該鎖定功能啟動。
-  延遲關機按鍵：
 - 按一下此鍵啟動延遲關機功能，自動進入最低風速，啟動計時5分鐘自動關機功能，但LED燈不受影響。
 - 延遲關機啟動時可變換風速上下，當執行計時中按蒸氣清洗鍵無效。
 - 延遲關機啟動時按一下延遲開關按鍵，只會關閉延遲功能，按電源/開關按鍵會直接關機結束風扇動作。

六. 按鍵說明-SC8230S/W & SC8236S/W



-  電源/開關按鍵：
 - (1) 按壓一次開啟風扇；再按壓一次關閉風扇。
-  電燈按鍵：
 - (1) 啟動燈泡時，LCD面板顯示 $L \overset{\circ}{\circ} H$ 。
 - (2) 按第一次全亮LCD面板顯示H，按第二次微亮LCD面板顯示L。
 - (3) 此按鍵獨立控制不受電源/開關按鍵和延遲開關按鍵影響。
-  延遲開關/風速控制按鍵：
 - (1) 按壓2秒不放後，啟動延遲關機功能，自動進入最低風速，計時5分鐘自動關機功能，LCD面板以  閃爍顯示，但鹵素燈不受影響。
 - (2) 運轉中途可變換風速上下，當執行計時中按蒸氣清洗鍵無效。
 - (3) 啟動中按一下延遲開關按鍵2秒，只會關閉延遲功能，按電源/開關按鍵會直接關機結束風扇動作。
 - (4) 風速上調控制至高速為止，下調控制至低速為止，每按一次則依序遞增或遞減，LCD面板分別顯示  (低) /  (中) /  (高)。
 - (5) 當風扇停止運轉時，按風速上或下鍵即以上次關機之速度啟動。
-  清洗按鍵：
 - (1) 按下開始清洗流程，LCD面板顯示 ，其餘時熄滅狀態。
 - (2) 啟動蒸氣清洗時，按風速上、下鍵皆無效。
 - (3) 缺水時，按此鍵無效且LCD面板以  閃爍顯示警告。
 - (4) 清洗功能異常時會啟動自動鎖定功能，LCD面板閃爍顯示  為警示該鎖定功能啟動。

六. 按鍵說明-SC8130S/W & SC8136S/W



1. 開/關按鍵 & 延遲關機按鍵:

(1) 開/關按鍵:

- 按壓一次開啟風扇；再按壓一次關閉風扇。
- 此按鍵有記憶功能，自第二次使用會在上次關機的速度和電燈段數啟動。

(2) 延遲關機按鍵:

- 按下此按鍵3秒鐘可啟動延遲關機功能。會自動進入最低風速，此按鍵會閃爍警示延遲關機功能已啟動。5分鐘後風扇和電燈會自動關閉。
- 延遲關機啟動時仍可調整風速。
- 延遲關機啟動時不可執行蒸氣清洗功能。

■ 當啟動風扇或蒸氣清洗，開/關按鍵會亮起。

■ 延遲關機風速指示燈說明: 低速: 只會閃爍 ▽ 按鍵。中速: 只會閃爍 ▲ 按鍵
高速: ▲ 和 ▽ 按鍵皆會閃爍。

2. 電燈按鍵:

- (1) 電燈為兩段式。按第一次全亮；按第二次微亮；再按一次可關閉電燈。

3. 風速加速按鍵:

- (1) 每按一次則速度遞增，至最高速為止。即 1 → 2 → 3 → 3 (高速)。
(2) 當風扇停止運轉時，按此按鍵會在上次關機的速度和電燈段數啟動。

4. 風速減速按鍵:

- (1) 每按一次則速度遞減，至最低速為止。即 3 → 2 → 1 → 1 (低速)。
(2) 當風扇停止運轉時，按此按鍵會在上次關機的速度和電燈段數啟動。

■ 風速指示燈說明: 低速: 只會亮起 ▽ 按鍵。中速: 只會亮起 ▲ 按鍵。
高速: ▲ 和 ▽ 按鍵皆會亮起。

5. 清洗按鍵:

- (1) 按下此按鍵啟動蒸氣清洗功能。
(2) 清洗時此按鍵恆亮。
(3) 執行蒸氣清洗功能時，不可執行風扇速度增減。
(4) 缺水時，按此按鍵無效並且會持續閃爍警示，直到加水為止。

■ 當缺水時，清洗按鍵會閃爍。

五. 安裝排風管

櫥櫃安裝注意事項：

安裝之風管、牆壁、櫥櫃空間、天花板或車庫與閣樓之間的空間都要有所保留。
風管只能使用金屬材質。

安裝之連接處的金屬螺絲要鎖緊，接頭處要用有認證的銀膠帶或風管膠帶貼緊。

風管安裝選項：

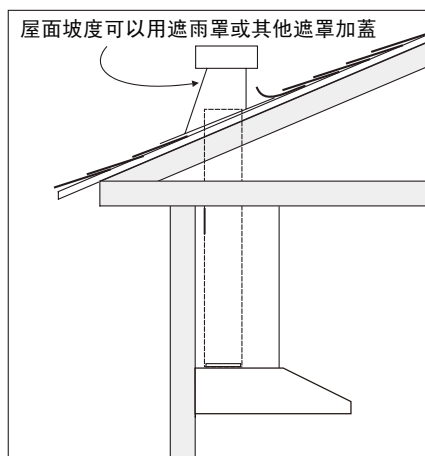
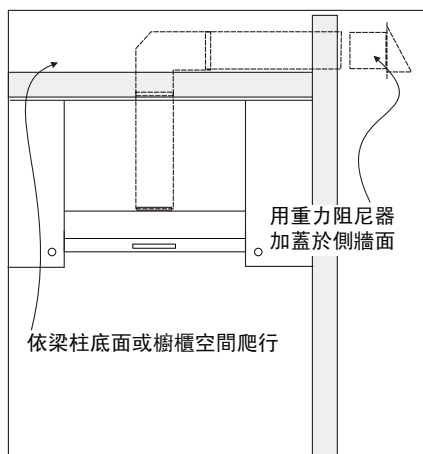
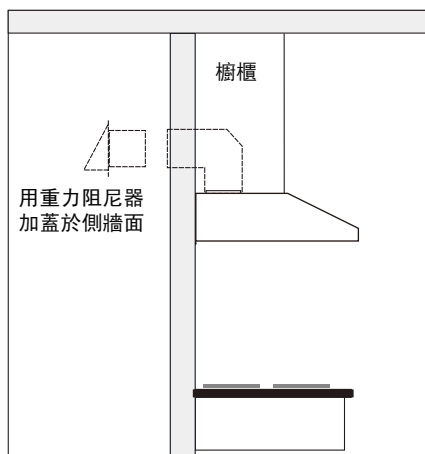

四. 安裝步驟-SC8230SW, SC8236SW, SC8830SW, SC8836SW

櫥櫃安裝說明:(如圖一)

1. 請準備安裝位置及空間。
2. 測量出風口及電源線孔的大小，然後再鑽孔。
3. 櫥櫃需加強本機固定的地方，建議使用木條強化在櫥櫃內底部。
4. 請用十字螺絲起子移除油機底板，卸下油機底板及燈泡電線。
5. 依安裝位置設置四支木螺釘。
6. 安裝時用木螺釘扣上之後，將油機與櫥櫃用螺絲鎖緊，讓油機與櫥櫃安全不會掉落。
7. 裝設電源。
8. 安裝風管並用風管膠帶密封。
9. 檢查風管處是否緊密及其他功能是否正常。
10. 將油機底板與燈泡重新安裝上去。
11. 將油杯與出風口安全網裝進油機。

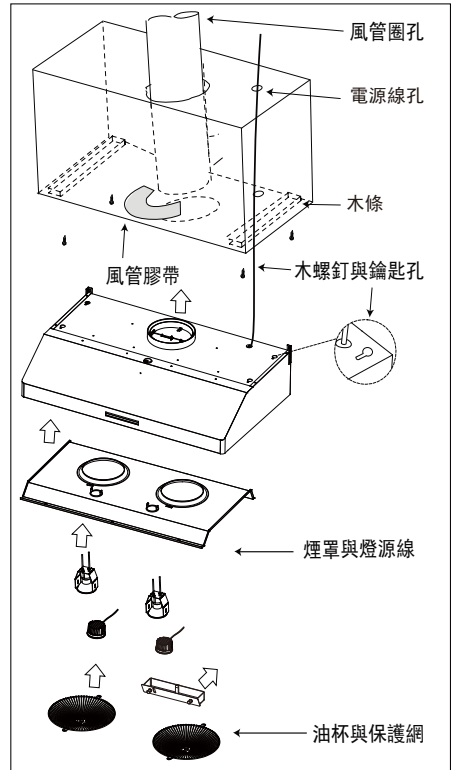

圖一

四. 安裝步驟-SC8130S/W & SC8136S/W

櫥櫃安裝說明:(如圖一)

1. 請準備安裝位置及空間。
2. 測量出風口及電源線孔的大小，然後再鑽孔。
3. 櫥櫃需加強本機固定的地方，建議使用木條強化在櫥櫃內底部。
4. 請用十字螺絲起子移除油機底板，卸下油機底板及燈泡電線。
5. 依安裝位置設置四支木螺釘。
6. 安裝時用木螺釘扣上之後，將油機與櫥櫃用螺絲鎖緊，讓油機與櫥櫃安全不會掉落。
7. 裝設電源。
8. 安裝風管並用風管膠帶密封。
9. 檢查風管處是否緊密及其他功能是否正常。
10. 將油機底板與燈泡重新安裝上去。
11. 將油杯與出風口安全網裝進油機。

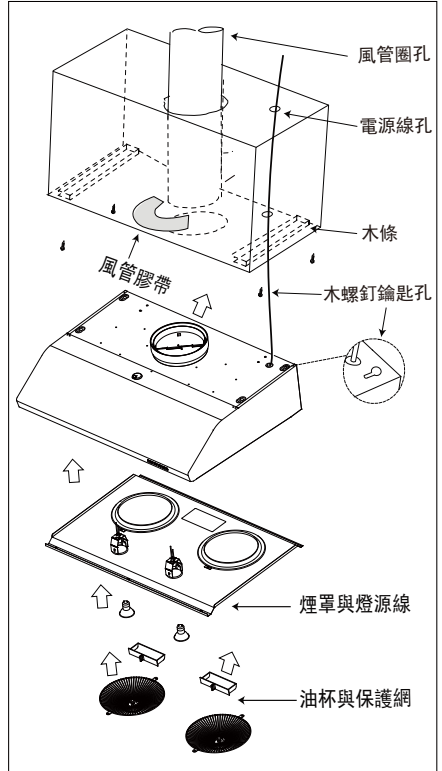

圖一

三. 安裝原則

1. 周圍環境(圖一):

抽油煙機安裝位置，如在窗上或附近有太多門窗，請在開動抽油煙機前，先關閉門窗，以免空氣對流大而影響吸力，因當油煙上昇未至10吋之有效吸力範圍，則無法充分發揮抽油煙最佳效果。

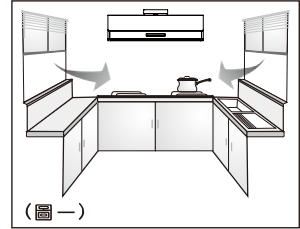

(圖一)

門窗太多、對流太大

2. 安裝高度(圖二):

安裝高度自本機底板至煮食爐面之距離以24~30吋為最理想。

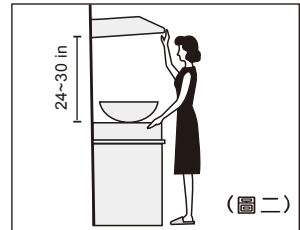

(圖二)

3. 機體應保持水平(圖三):

機體應保持前、後、左、右水平，以免氣流箱，導油盆積油而溢出。

左、右水平可由掛碼調整，前、後水平則由鋼丁螺絲鎖緊牆壁，以固定標準。

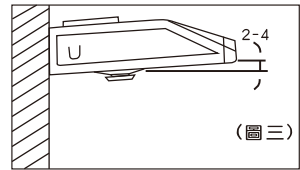

(圖三)

4. 排風管:

為增加吸力效能，請配合使用本機出風管接頭之直徑7吋排風管，排風管長度應以適合長度最佳，不宜過長。

5. 插座安排:

請勿與烤箱或冰箱等耗電量較高之電器產品共用一個插座。

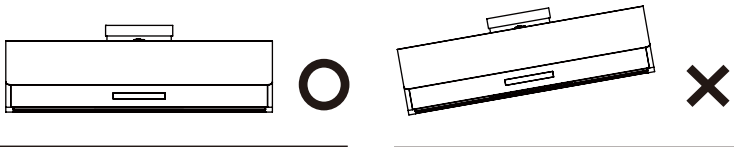

※ 安裝前先以矽利康注入風管圈後將風管嵌入，再用封膠封住風管圈。

二. 配件說明-SC8230S/W, SC8236S/W, SC8830S/W, SC8836S/W

零件名稱：

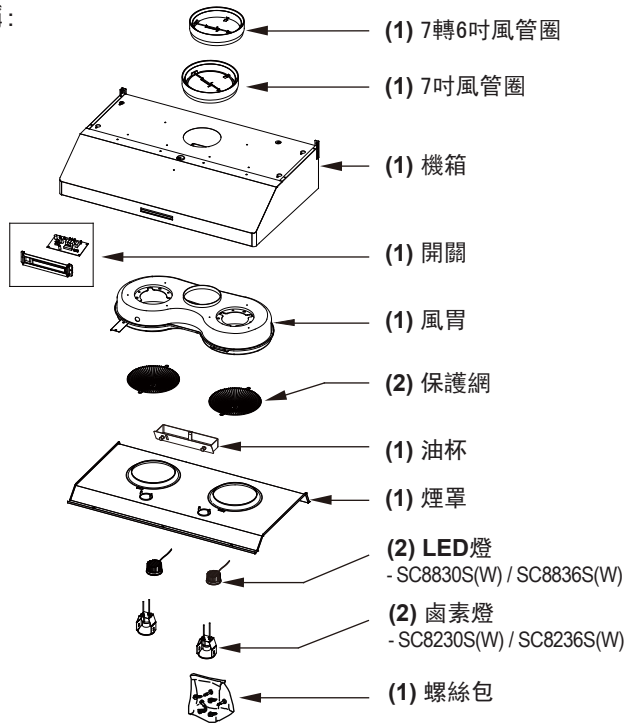

螺絲包配件(加拿大地區)：

序號	圖示	種類	數量	序號	圖示	種類	數量
A		P3螺母	3	C		M6 x 1-1/2吋木螺絲	4
B		5 x 24m/m 華司	4	D		鹵素燈拆裝吸盤 SC8230S(W) / SC8236S(W)	1
E		M4*8傘頭2種牙螺絲鍊	4				

螺絲包配件(美國地區)：

序號	圖示	種類	數量	序號	圖示	種類	數量
A		P3螺母	3	E		鹵素燈拆裝吸盤 SC8230S(W) / SC8236S(W)	1
B		5 x 24m/m 華司	4	F		M6 x 2吋木螺絲	4
C		3/16 x 1/2 平頭田丸 十字螺絲	4	G		M6 x 1吋木螺絲	2
D		M6 x 1-1/2吋木螺絲	4	H		吊掛組	2

二. 配件說明- SC8130S/W & SC8136S/W

零件名稱：

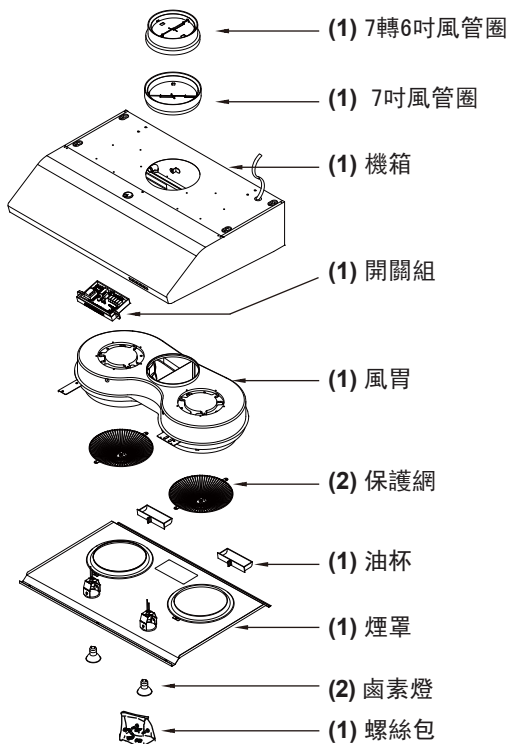

螺絲包配件(加拿大地區)：

序號	圖示	種類	數量	序號	圖示	種類	數量
A		P3螺母	3	C		M6 x 1-1/2吋木螺絲	4
B		5 x 24m/m 華司	4	D		鹵素燈拆裝吸盤	1

螺絲包配件(美國地區)：

序號	圖示	種類	數量	序號	圖示	種類	數量
A		P3螺母	3	E		鹵素燈拆裝吸盤	1
B		5 x 24m/m 華司	4	F		M6 x 2吋木螺絲	4
C		3/16 x 1/2 平頭田九 十字螺絲	4	G		M6 x 1吋木螺絲	2
D		M6 x 1-1/2吋木螺絲	4	H		吊掛組	2

一. 功能簡介/性能規格表

A. 產品功能

1. 不停電狀況下，操作風速可記憶。
2. 風速選擇。
3. 可以控制照明燈的開/關，具亮、暗二段調整。
4. 具有延遲功能。
5. 蒸氣清洗(蒸氣洗淨功能)。
6. 指示燈顯示(SC88/SC82)/LED藍光背光顯示(SC81):風速、清洗、延遲關機。
按鍵功能:開/關、風速增減、光源、延遲關機、蒸氣清洗。

B. 規格表

型 號	SC8130S(W)	SC8136S(W)
重 量(英磅)	33.66 磅	36.86 磅
尺 寸(英吋)	36"X22-1/16"X7-1/16"	36"X22-1/16"X7-1/16"
最大伏特數	120V – 60Hz	120V – 60Hz
風 管 直 徑	7 吋	7 吋
燈 泡	鹵素燈 35Wx2	鹵素燈 35Wx2
最大消耗功率	10A/1200W	10A/1200W

型 號	SC8230S(W) / SC8830S(W)	SC8236S(W) / SC8836S(W)
重 量(英磅)	38.14磅	42.11磅
尺 寸(英吋)	30"X23"X8"	36"X23"X8"
最大伏特數	120V – 60Hz	120V – 60Hz
風 管 直 徑	7 吋	7 吋
燈 泡	LED 燈 3Wx2/鹵素燈 50Wx2	LED 燈 3Wx2/鹵素燈 50Wx2
最大消耗功率	10A/1200W	10A/1200W

目錄

一. 功能簡介/性能規格表	1
二. 配件說明-SC8130S/W,SC8136S/W	2
配件說明-SC82xxS/W & SC88xxS/W	3
三. 安裝原則	4
四. 安裝步驟-SC8130S/W,SC8136S/W	5
安裝步驟-SC82xxS/W & SC88xxS/W	6
五. 安裝排風管	7
六. 按鍵說明-SC8130S/W,SC8136S/W	8
按鍵說明-SC8230S/W,SC8236S/W	9
按鍵說明-SC8830S/W,SC8836S/W	10
七. 移除燈泡	11
八. 機身表面保養和清潔	12
九. 注意事項	13
十. 排除故障	14

PACIFIC

TRU**ST**EAM

抽油煙機 使用說明書

抽油機型號： SC8130S / SC8136S / SC8130W / SC8136W

SC8230S / SC8236S / SC8230W / SC8236W
SC8830S / SC8836S / SC8830W / SC8836W



序 號： _____

(使用前，請先詳細閱讀此說明書)